

Item: 0.5 oz Cylindrical Vial
Family: Browse Cylinder

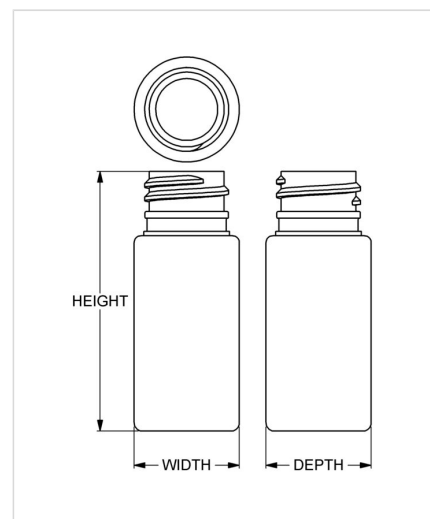

Specifications

- | | |
|-------------------------------------|---|
| • Capacity 15 ml/cc / 0.5 oz | • Height 60.91 mm / 2.398 in |
| • Mold # 0543 | • Width 24.64 mm / 0.970 in |
| • Finish 20-410 | • Depth 24.64 mm / 0.970 in |
| • Finish Code D2 | • Overflow 19 ml/cc / 0.6 oz |
| • Weight 8.5 g / 0.30 oz | • Max. Bead Diameter 19.89 mm / 0.783 in |
| • Other Weights No | • Material Options PET |